



### Material

Formed 11 gauge / 304 stainless steel and Ø3/4" stainless steel solid round stock (no hollow or tubular components).

### Design

Engineered to fit (2) standard bins/totes (not included).

### Construction

All contact points are TIG welded complete and the cart is fully assembled.

### Finish

All components receive a dual-action medium Scotch-Brite finish and all welds are passivated.

### Footing

Casters – (2) 4" swivel with total locking brake & (2) 4" swivel casters with 1/2" stainless steel spacers and hardware

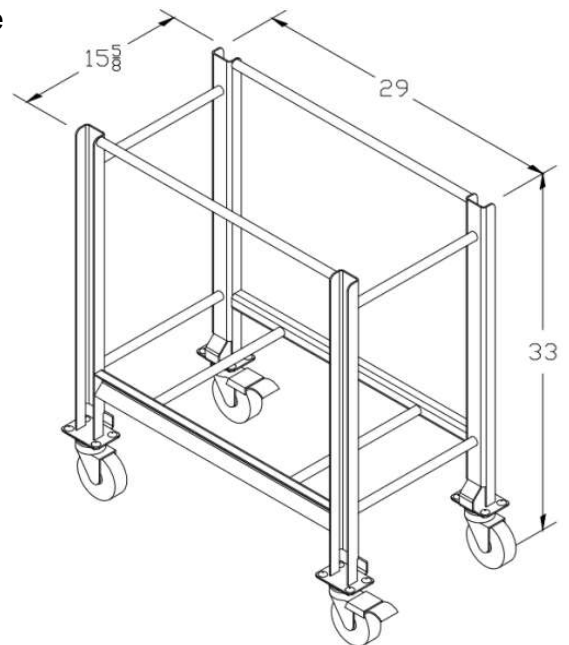

### Pricing

Model No.	Price / Ea. @ Qty:		
	1	5	10
SSL-1065	\$975	\$945	\$925

**SSL Industries, LLC**

Phone: (920) 893-2991

Get a Quote: [sales@sslindustries.com](mailto:sales@sslindustries.com)

[www.sslindustries.com](http://www.sslindustries.com)